

LK 270	S98 W24 G67
LK 271	S148 W24 G67
LK 272	S197 W24 G67

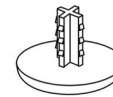

x4



x4



x4

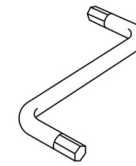

x1

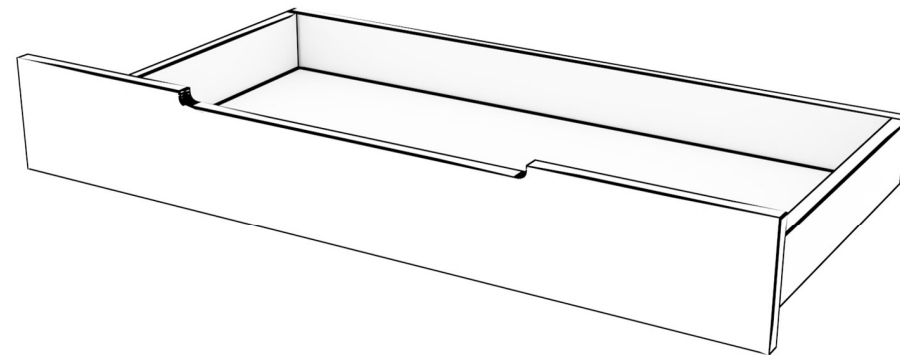

PL : Dla wzmocnienia konstrukcji zaleca się przykręcenie stelaża do ramy łóżka
SK : Pre posilnenie konštrukcie, odporúčame rám roštu priskrutkovať na rám posteľe
EN : To strengthen the bed construction it is recommended to screw the slat under the mattress to frame of the bed
CS : Prt posílenie štruktúry, doporučuje sa šroub rámeček na rám posteľe

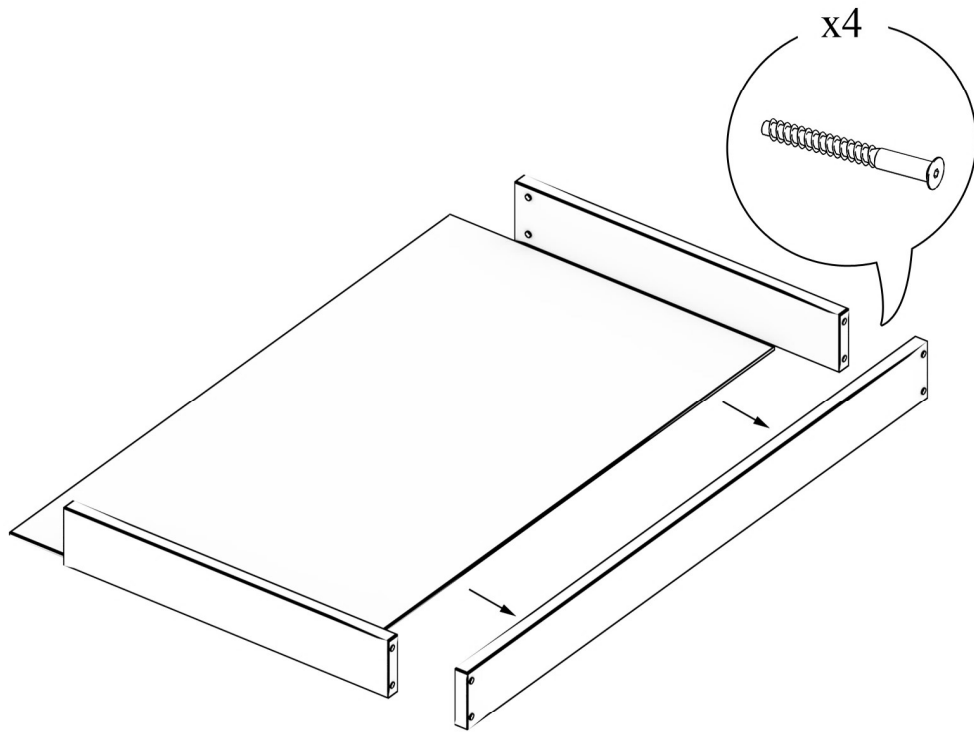

1.

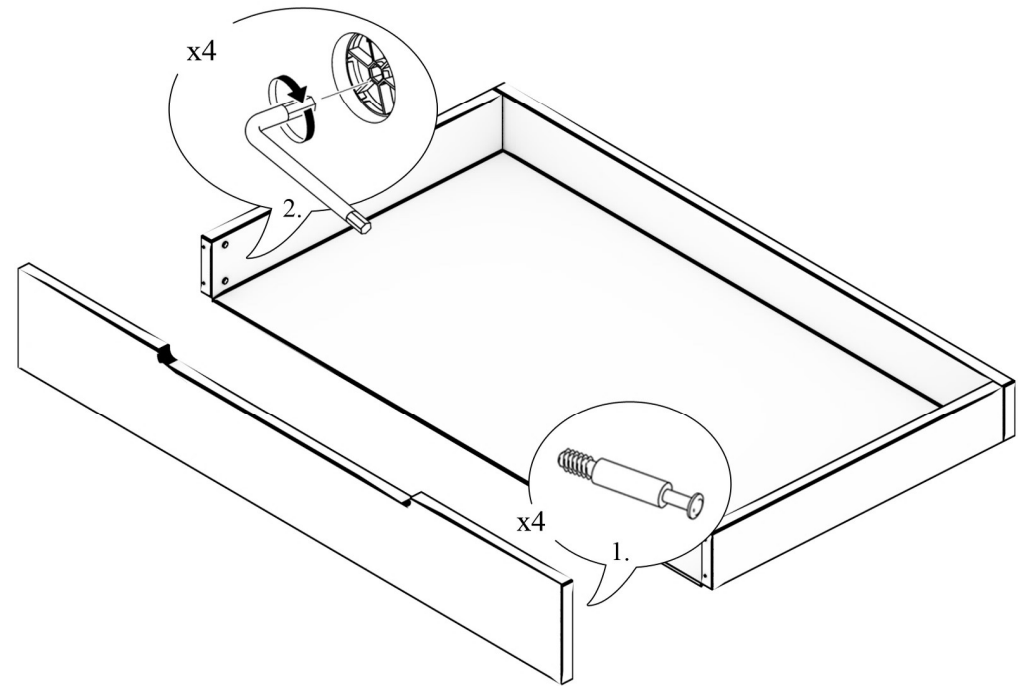

2.